

MODULARITÀ

N.B. - LE ALTEZZE DI TUTTI GLI ELEMENTI SONO COMPRESIVE DI PIEDINI REGOLABILI (H.0±10 mm)

BASI A TERRA: H. 88.1

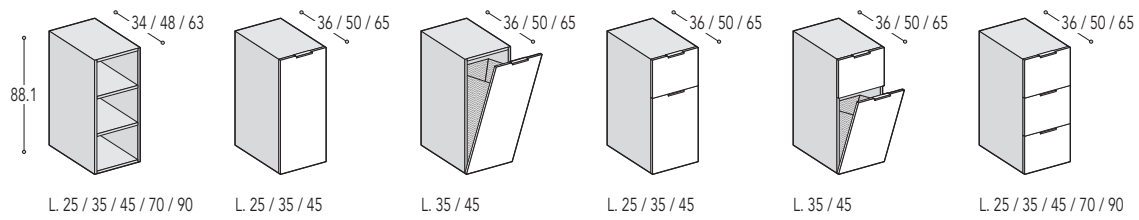

BASI A TERRA: H. 88.1

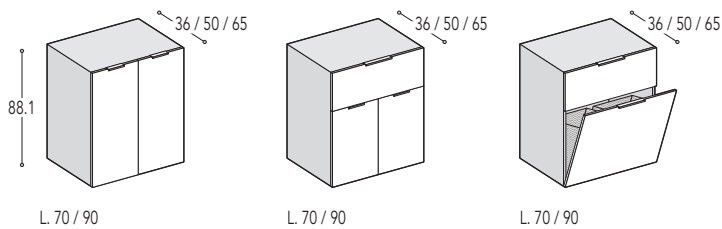

BASE P/LAVATRICE A TERRA: H. 88.1

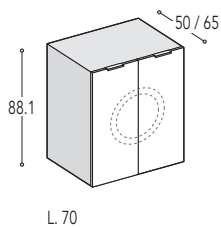

BASI P/VASCA a TERRA: H. 88.1

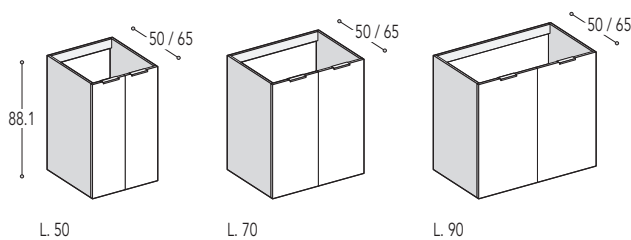

MODULARITÀ

N.B. - LE ALTEZZE DI TUTTI GLI ELEMENTI SONO COMPRESIVE DI PIEDINI REGOLABILI (H.0±10 mm)

LAVATOI H.88.1 con VASCA IN CERAMICA

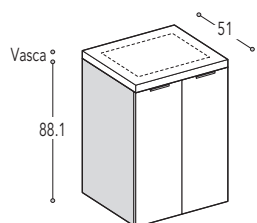

L. 61
Vasca "YORK" Sp. 2.4 cm

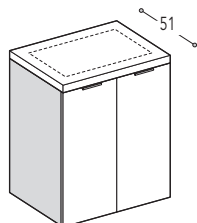

L. 71
Vasca "SCOTT" Sp. 2.4 cm

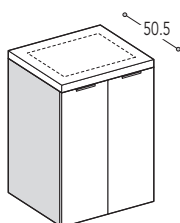

L. 60
Vasca "FORTY" Sp. 2.1 cm

LAVATOI H.88.1 con VASCA IN MINERALMARMO "NIC" Sp.2.2 cm

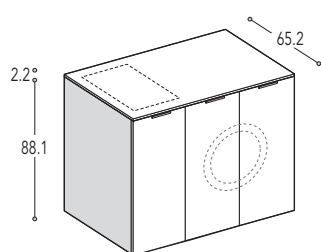

L. 108

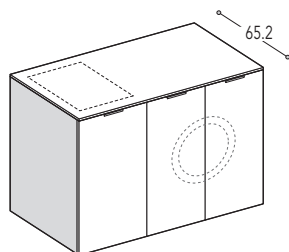

L. 123

LAVATOI H.88.1 con VASCA IN METACRILATO "YDRO" Sp.3 cm

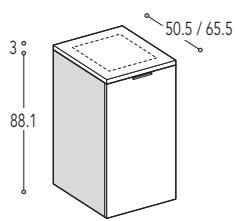

L. 46

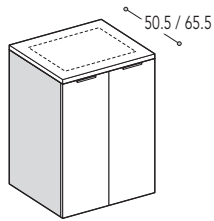

L. 60

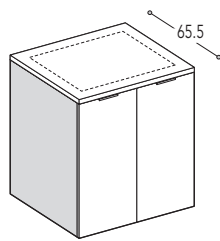

L. 76

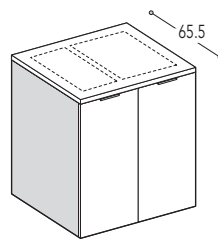

L. 76

LAVATOI H.88.1 con VASCA IN METACRILATO "YDRO" Sp.3 cm

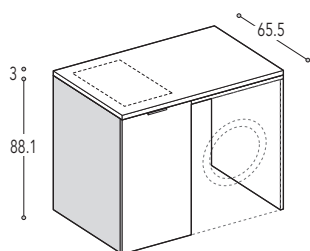

L. 109

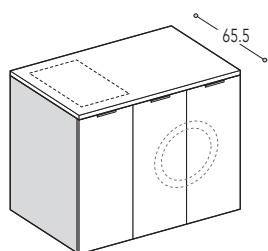

L. 109

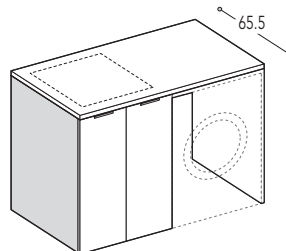

L. 124

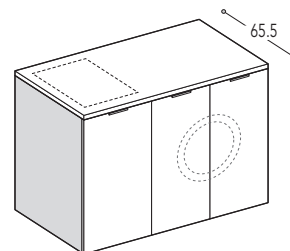

L. 124

MODULARITÀ

N.B. - LE ALTEZZE DI TUTTI GLI ELEMENTI SONO COMPRESIVE DI PIEDINI REGOLABILI (H.0±10 mm)

PENSILI: H. 70

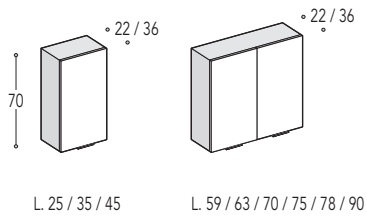

PENSILI SPECCHIO CONTENITORE: H. 70

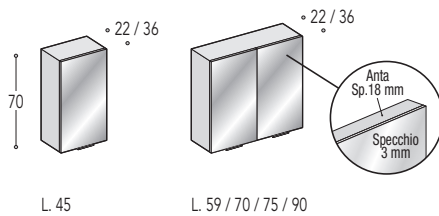

SEMI-COLONNE A TERRA: H. 117

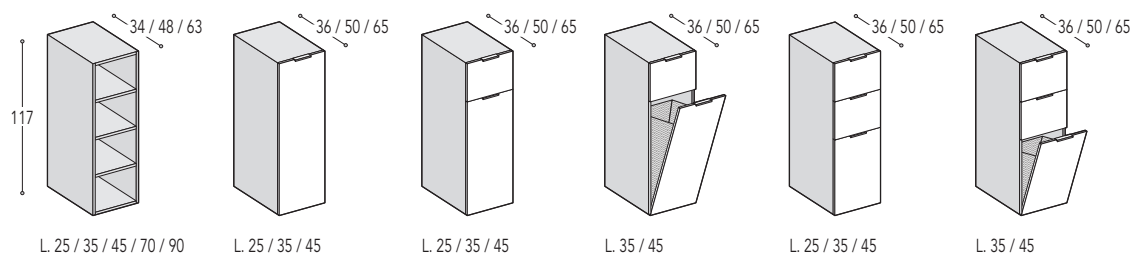

SEMI-COLONNE A TERRA: H. 117

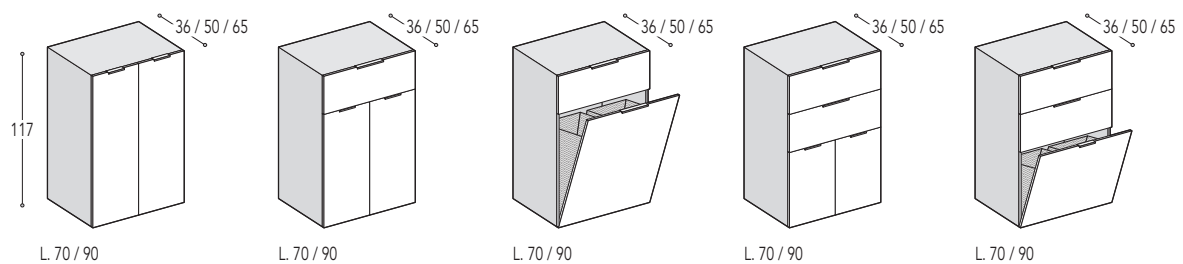

MODULARITÀ

N.B. - LE ALTEZZE DI TUTTI GLI ELEMENTI SONO COMPRESIVE DI PIEDINI REGOLABILI (H.0±10 mm)

COLONNE A TERRA: H. 203.4

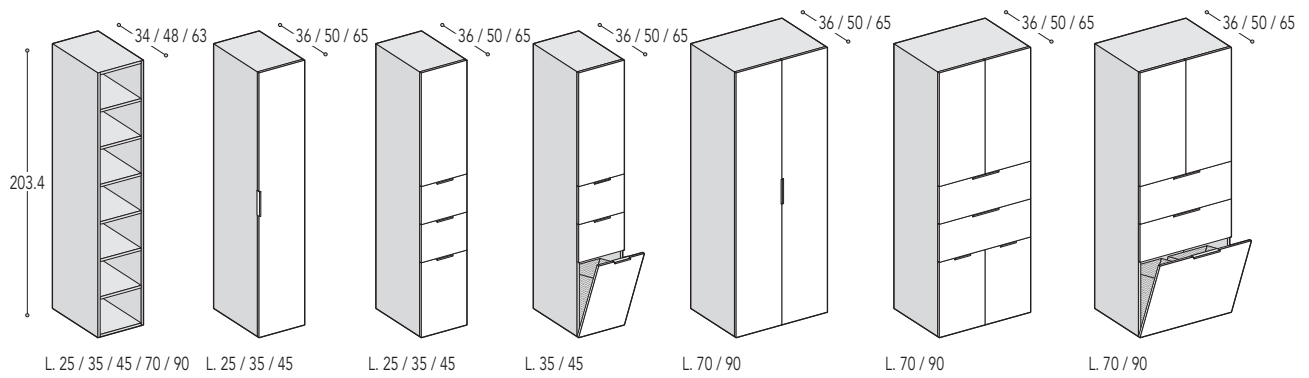

COLONNE P/SCOPE A TERRA: H. 203.4

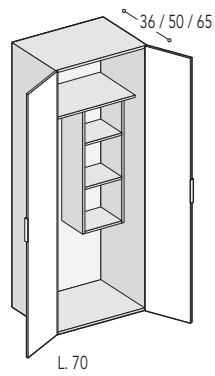
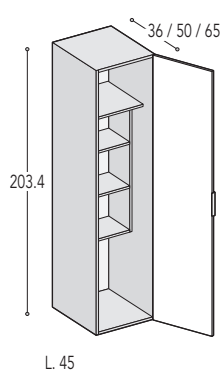

COLONNA PORTA ASSE DA STIRO A TERRA: H.203.4

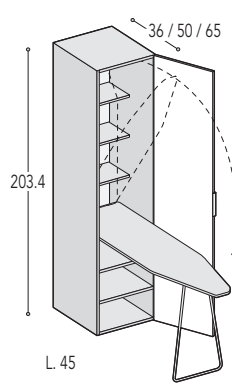

COLONNE P/LAVATRICE A TERRA: H. 203.4

